



IE3
Premium Efficiency

1-PHASE INDUCTION MOTORS
SERIES 3SSIE



1-PHASE INDUCTION MOTORS

SERIES 3SSIE

TD 229
Version V_01, 01-07-2020
Changes and misprints reserved

Kolmer Elektromotoren B.V.
Industrieweg 16
3881 LB Putten
The Netherlands
Tel. +31 (0) 341 - 369 696
Fax +31 (0) 341 - 369 690
E-mail: info@kolmerelectricmotors.com
Website: www.kolmerelectricmotors.com

Contents

1. General information	5
1.1. Cantoni product range	5
1.2. Standards	5
1.3. Standard operating conditions	6
1.4. Tolerances of motor parameters.....	6
1.5. Mounting arrangements	7
1.6. Terminal box equipment	8
1.7. Bearings	9
1.8. Permissible loads on the shaft end.....	10
2. 3SSIE series	11
2.1. Technical data	11
2.2. Spare parts	13



1. General information

1.1. Cantoni product range

Cantoni offers a full range of induction electric motors, from 0,04 kW up to 6000 kW, in standard and special executions. Cantoni motors operate in almost all industrial segments like: pumps, fans, compressors, conveyors, mining, power plants and many other fields. The Cantoni product range consists of standard motors according to IEC standard in efficiency classes IE1, IE2, IE3, IE4 and motors according to NEMA standard e.g. NEMA Premium motors. Apart from standard motors, it is possible to offer motors for special applications in marine, oil, gas, energy, construction and many other industries. All main components of the motors are produced in Europe (Poland) in order to guarantee the highest quality level. Particular importance is attached to the raw materials used for production, they are delivered only by qualified suppliers exclusively from the European Union.

The designs and solutions correspond to the customer requirements and international norms. All motors are manufactured according to Quality Management System consistent with ISO 9001 and Environmental Management System consistent with ISO 14001. Cantoni motors are provided with CE mark and fulfil the EU Directives regarding the safety measures. The motors comply with almost all international standards: German standards DIN VDE, British standards BS, Italian standards CEI and on request Canadian standards CSA, American standards UL, NEMA or EU standard ATEX.

1.2. Standards

The electric motors are manufactured according to the international standards:

Description	Standard
Rating and performance	IEC 60034-1
Methods for determining losses and efficiency	IEC 60034-2-1
Classification of degrees of protection	IEC 60034-5
Methods of cooling	IEC 60034-6
Symbols of construction and mounting arrangements	IEC 60034-7
Terminal markings and direction of rotation	IEC 60034-8
Noise limits	IEC 60034-9
Dimensions and output of electric machines	IEC 60072-1
Vibration limits	IEC 60034-14

1.3. Standard operating conditions

Cantoni motors can operate under the following conditions:

- Motor of series 3SSIE are efficiency class IE3
- Motors are insulated with Class F (105K) materials and Class B temperature rise
- PTC thermistors are available on request
- The standard degree of enclosure protection is IP55. Shafts are fitted with oil seal as standard
- The cooling method is IC411: TEFC (Totally Enclosed Fan Cooled)
- The standard voltage of the motors is 230V at a frequency of 50 Hz
- Motors are suitable for operating mode S1 (continuous operation)
- Motors are suitable to operate at an ambient temperature of -20°C / +40°C
- Motors are balanced Class A (½ key)

For other operating conditions, please contact Kolmer to check whether this condition is suitable or not.

1.4. Tolerances of motor parameters

Permissible deviations between real values and catalogue values according to IEC 60034-1:

Description	Permissible deviations
Power factor $\cos \varphi$	$\Delta \cos \varphi = -\frac{1}{6} \cdot (1 - \cos \varphi_N)$
Efficiency η	$\Delta \eta = -15\% \cdot (100 - \eta_N)$ for $P_N \leq 150$ kW $\Delta \eta = -10\% \cdot (100 - \eta_N)$ for $P_N > 150$ kW
Speed n	$\Delta n = \pm 20\% \cdot (n_s - n_N)$ for $P_N > 1$ kW $\Delta n = \pm 30\% \cdot (n_s - n_N)$ for $P_N \leq 1$ kW
Locked rotor current I_L/I_N	$\Delta \frac{I_L}{I_N} = +20\% \cdot \frac{I_L}{I_N}$
Locked rotor torque T_L/T_N	$\text{Min} \frac{T_L}{T_N} = -15\% \cdot \frac{T_L}{T_N}$ $\text{Max} \frac{T_L}{T_N} = +25\% \cdot \frac{T_L}{T_N}$
Breakdown torque T_B/T_N	$\Delta \frac{T_B}{T_N} = -10\% \cdot \frac{T_B}{T_N}$
Moment of inertia J [kg·m ²]	$\Delta J = \pm 10\% \cdot J$
Sound pressure level L_{PA} [dB]	$\Delta L_{PA} = +3$ dB /A/



Standard motors comply with Voltage value and frequency variations within zone A according IEC 60034-1. Other tolerances of supply Voltage and their frequency are available on request.

Description	Permissible deviations
Voltage value U	$\Delta U = \pm 5\%$
Frequency f	$\Delta f = \pm 2\%$

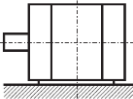
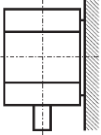
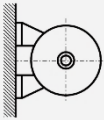

1.5. Mounting arrangements

The most commonly used mounting arrangements are shown in the table below. Other mounting arrangements are available on request. According to the safety standard for electrical machines, foreign objects must be prevented from falling into the fan cover. On request, a protective hood (rain cover) can be mounted over the fan cover.

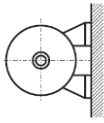
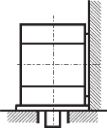
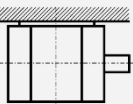
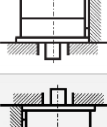
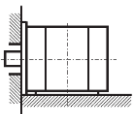
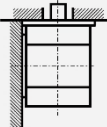
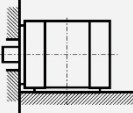
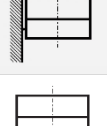
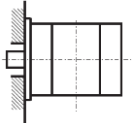
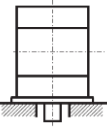
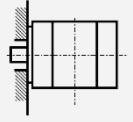
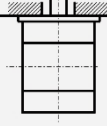
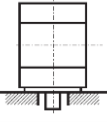
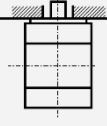
Horizontal shaft				Vertical shaft			
	IEC EN 60034-7 code II	IEC EN 60034-7 code I	Frame size		IEC EN 60034-7 code II	IEC EN 60034-7 code I	Frame size
	IM 1001	IM B3	63-80		IM 1011	IM V5	63-80
	IM 1051	IM B6	63-80		IM 1031	IM V6	63-80
	IM 1061	IM B7	63-80		IM 2011	IM V15	63-80
	IM 1071	IM B8	63-80		IM 2111	IM V17	63-80
	IM 2001	IM B35	63-80		IM 2031	IM V36	63-80
	IM 2101	IM B34	63-80		IM 2131	IM V37	63-80
	IM 3001	IM B5	63-80		IM 3011	IM V1	63-80
	IM 3601	IM B14	63-80		IM 3031	IM V3	63-80
					IM 3611	IM V18	63-80
					IM 3631	IM V19	63-80

1.6. Terminal box equipment

Frame size	Number of terminals	Terminal size	Terminal box position	Cable glands	Cable gland direction	Temperature sensors
63	6	M4	Top	M20 (1x)	To right	On request
71	6	M4	Top	M20 (1x)	To right	On request
80	6	M4	Top	M20 (1x)	To right	On request

1.7. Bearings

Frame size	Number of poles	Bearing DE	Bearing NDE
63	2 - 8		6202 2Z C3
71	2 - 8		6203 2Z C3
80	2 - 8		6204 2Z C3

1.8. Permissible loads on the shaft end

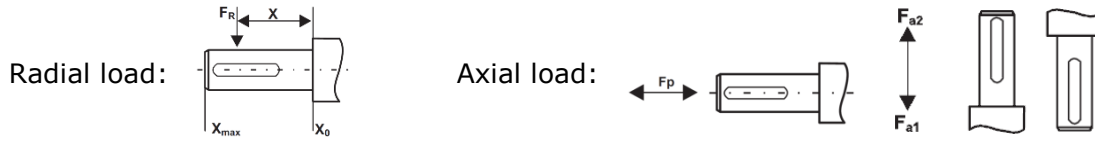

Frame size	Number of poles	Horizontal operation		Vertical operation		
		$F_R (X=0)$	$F_R (X=\max)$	F_P	F_{a1}	F_{a2}
63	2	0,20	0,16	0,04	0,04	0,06
	4	0,25	0,20	0,06	0,05	0,07
71	2	0,29	0,24	0,07	0,05	0,09
	4	0,36	0,30	0,09	0,07	0,11
80	2	0,33	0,27	0,09	0,06	0,12
	4	0,44	0,37	0,12	0,09	0,15



2. 3SSIE series

2.1. Technical data

2-Pole motors (3000 rpm)

Type	Rated output	Rated speed	Rated torque	Efficiency	Power Factor	Full load current	Locked rotor current	Locked rotor torque	Breakdown torque	Moment of inertia	Start capacitor	Run capacitor	Sound pressure level	Netto weight B3
	P_N [kW]	n_N [min ⁻¹]	T_N [N·m]	η_N [%] 100% load	$\cos\phi_N$ [-]	I_N [A] 230V	I_L/I_N [-]	T_L/T_N [-]	T_B/T_N [-]	J [kg·m ²]	[μ F/450V]		L_{PA} [dB]	m [kg]
Standard starting torque														
3SSIE 63-2A	0,18	2870	0,60	70,0	0,97	1,1	3,8	0,40	1,6	0,00017		16		3,7
3SSIE 63-2B	0,25	2890	0,83	73,0	0,94	1,6	4,5	0,35	2,0	0,00024		20		4,3
3SSIE 71-2A	0,37	2880	1,23	73,8	0,99	2,2	3,8	0,30	1,6	0,00048		25		6,2
3SSIE 71-2B	0,55	2870	1,83	77,8	0,99	3,1	3,5	0,30	1,6	0,00069		35		8,0
3SSIE 80-2A	0,75	2880	2,49	80,7	0,96	4,2	4,2	0,30	1,6	0,00100		50		10,8
3SSIE 80-2B	1,1	2900	3,62	82,7	0,99	5,8	5,4	0,30	2,0	0,00142		70		12,1
High starting torque (electronic switch)														
3SSIE 63-2AR	0,18	2870	0,60	70,0	0,97	1,1	4,1	1,5	1,6	0,00017	40	16		3,7
3SSIE 63-2BR	0,25	2890	0,83	73,0	0,94	1,6	4,7	1,7	2,0	0,00024	50	20		4,3
3SSIE 71-2AR	0,37	2880	1,23	73,8	0,99	2,2	4,1	1,5	1,6	0,00048	90	25		6,2
3SSIE 71-2BR	0,55	2870	1,83	77,8	0,99	3,1	3,8	1,5	1,6	0,00069	110	35		8,0
3SSIE 80-2AR	0,75	2880	2,49	80,7	0,96	4,2	5,1	1,5	1,6	0,0100	120	50		10,8
3SSIE 80-2BR	1,1	2900	3,62	82,7	0,99	5,8	6,3	1,6	2,0	0,00142	500	70		12,1
High starting torque (centrifugal switch)														
3SSIE 63-2AF	0,18	2870	0,60	70,0	0,97	1,1	4,1	1,5	1,6	0,00017	40	16		3,7
3SSIE 63-2BF	0,25	2890	0,83	73,0	0,94	1,6	4,7	1,7	2,0	0,00024	50	20		4,3
3SSIE 71-2AF	0,37	2880	1,23	73,8	0,99	2,2	4,1	1,5	1,6	0,00048	90	25		6,2
3SSIE 71-2BF	0,55	2870	1,83	77,8	0,99	3,1	3,8	1,5	1,6	0,00069	110	35		8,0
3SSIE 80-2AF	0,75	2880	2,49	80,7	0,96	4,2	5,1	1,5	1,6	0,0100	120	50		10,8
3SSIE 80-2BF	1,1	2900	3,62	82,7	0,99	5,8	6,3	1,6	2,0	0,00142	200	70		12,1

4-Pole motors (1500 rpm)

Type	Rated output	Rated speed	Rated torque	Efficiency	Power Factor	Full load current	Locked rotor current	Locked rotor torque	Breakdown torque	Moment of inertia	Start capacitor	Run capacitor	Sound pressure level	Netto weight B3
	P_N [kW]	n_N [min ⁻¹]	T_N [N·m]	η_N [%] 100% load	$\cos\phi_N$ [-]	I_N [A] 230V	I_L/I_N [-]	T_L/T_N [-]	T_B/T_N [-]	J [kg·m ²]	[μF/450V]		L_{PA} [dB]	m [kg]
Standard starting torque														
3SSIE 63-4B	0,18	1400	1,23	69,9	0,98	1,1	2,7	0,35	1,4	0,00077		16		6,1
3SSIE 63-4C	0,25	1420	1,68	73,5	0,94	1,5	3,2	0,35	1,5	0,00088		20		6,7
3SSIE 71-4A	0,25	1420	1,68	73,5	0,94	1,5	3,2	0,35	1,5	0,00101		20		7,7
3SSIE 71-4B	0,37	1440	2,45	77,3	0,94	2,2	2,8	0,30	1,7	0,00156		30		8,0
3SSIE 80-4A	0,55	1430	3,69	80,8	0,98	3,0	3,7	0,30	1,3	0,00208		40		9,8
3SSIE 80-4B	0,75	1430	5,01	82,5	0,96	4,1	4,0	0,30	1,6	0,00265		50		11,2
High starting torque (electronic switch)														
3SSIE 63-4BR	0,18	1400	1,23	69,9	0,98	1,1	3,3	1,5	1,4	0,00077	35	16		6,1
3SSIE 63-4CR	0,25	1420	1,68	73,5	0,94	1,5	3,6	1,5	1,5	0,00088	40	20		6,7
3SSIE 71-4AR	0,25	1420	1,68	73,5	0,94	1,5	3,7	1,7	1,5	0,00101	50	20		7,7
3SSIE 71-4BR	0,37	1440	2,45	77,3	0,94	2,2	3,1	1,5	1,7	0,00156	50	30		8,3
3SSIE 80-4AR	0,55	1430	3,69	80,8	0,98	3,0	4,0	1,7	1,3	0,00208	90	40		9,8
3SSIE 80-4BR	0,75	1430	5,01	82,5	0,96	4,1	4,1	1,5	1,6	0,00265	120	50		11,2
High starting torque (centrifugal switch)														
3SSIE 63-4BF	0,18	1400	1,23	69,9	0,98	1,1	3,3	1,5	1,4	0,00077	35	16		6,1
3SSIE 63-4CF	0,25	1420	1,68	73,5	0,94	1,5	3,6	1,5	1,5	0,00088	40	20		6,7
3SSIE 71-4AF	0,25	1420	1,68	73,5	0,94	1,5	3,7	1,7	1,5	0,00101	50	20		7,7
3SSIE 71-4BF	0,37	1440	2,45	77,3	0,94	2,2	3,1	1,5	1,7	0,00156	50	30		8,3
3SSIE 80-4AF	0,55	1430	3,69	80,8	0,98	3,0	4,0	1,7	1,3	0,00208	90	40		9,8
3SSIE 80-4BF	0,75	1430	5,01	82,5	0,96	4,1	4,1	1,5	1,6	0,00265	120	50		11,2



2.2. Spare parts

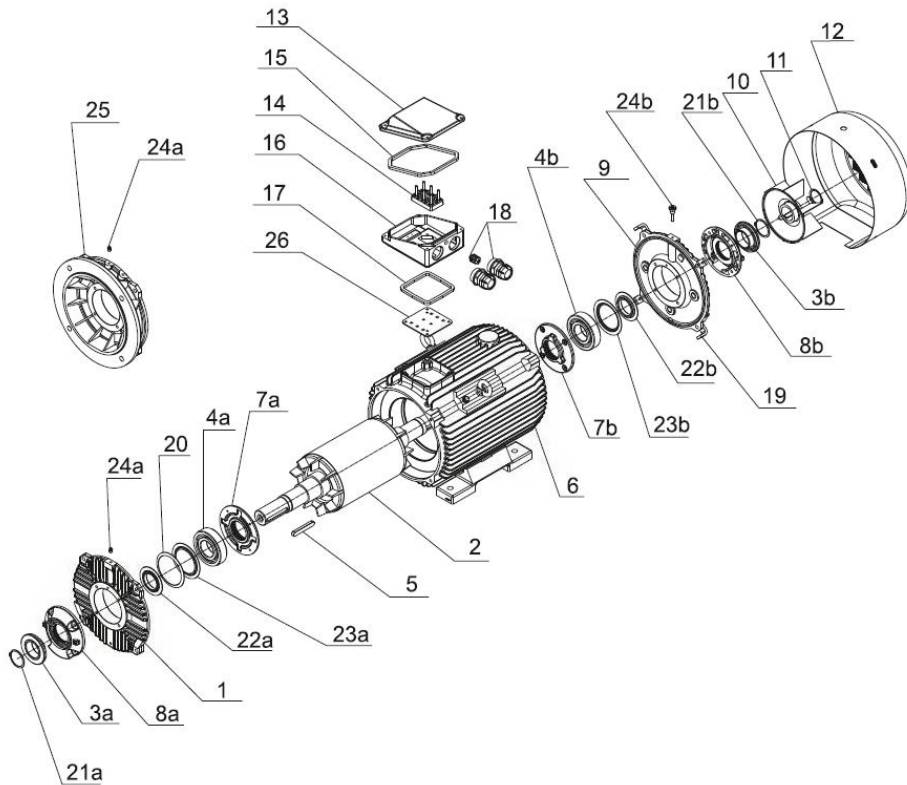

#	Description
1	DE shield
2	Rotor
3	Shaft seal
4	Bearing
5	Key
6	Housing with feet
7	Internal bearing cap
8	External bearing cap
9	NDE shield
10	Fan
11	Seeger ring
12	Fan cover
13	Terminal box cover

#	Description
14	Terminal board
15	Rubber gasket
16	Terminal box housing
17	Rubber gasket
18	Cable glands
19	Fan cover support
20	Spring washer
21	Seeger ring
22	Grease shield
23	Bearing internal ring
24	Grease nipple
25	Flange B5
26	Rubber gasket



📍 Industrieweg 16, 3881 LB Putten
☎ +31 (0) 341 - 369 696
🌐 www.kolmerelectricmotors.com

MOTORS WITH ADDED VALUE